

Specialized tech, Economical price, Reliable quality, Original idea!

OPERATION MANUAL

DEHUMIDIFIER
MODEL : DS-060



• Please read this operation manual before using the dehumidifier

CONTENTS

◆ Safety Instruction	3
◆ Attention during Usage	4-5
◆ Principle of dehumidifier	6
◆ Specification	6
◆ Descriptions of Parts	7
◆ Panel Control	8
◆ Remote Controller	9-10
◆ Operation Guide	11
◆ AUTO Operation Mode	12
◆ Air Direction Adjustment	13
◆ Timer Operations	14
◆ Defrost system	15
◆ Water drainage system	15
◆ Error codes	16
◆ Wiring diagram	16
◆ Maintenance	17-19
◆ Trouble Shooting	20

Safety Instruction



- Please read the following Safety Instructions carefully prior to use.
- The instructions are classified into two levels, WARNING and CAUTION according to the seriousness of possible risks and damages as follows. Compliance to the instructions are strictly required for safety use.

Installation

 WARNING	
<p>Please call Sales/Service Shop for the Installation.</p> <p>Do not attempt to install the air conditioner by yourself because improper works may cause electric shock, fire, water leakage.</p>	

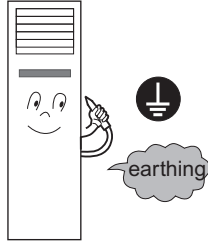
Installation in a inadequate place may cause accidents. Do not install in the following place.

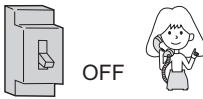
 CAUTION		
<p>Connect the earth cable.</p> 	<p>Do not install in the place where there is any possibility of inflammable gas leakage around the unit.</p> <p style="text-align: center;"> PROHIBITION</p>	<p>Do not get the unit exposed to vapor or oil steam.</p> <p style="text-align: center;"> PROHIBITION</p>

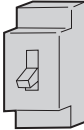
 WARNING	
<p>When abnormality such as burnt-smell found, immediately stop the operation button and contact sales shop.</p>  <p style="text-align: center;"> STRICT ENFORCEMENT</p>	<p>Use an exclusive power source with a circuit breaker</p> 

Attention during Usage

⚠ WARNING

- **Ensure the power plug is secure**
If the plug is not secure, it may cause a electric shock, over-heating or a fire.

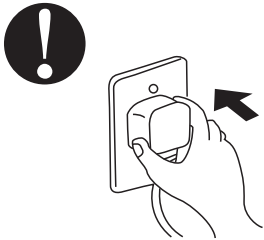

- **Never pull out the power plug during operation.**
otherwise, it may cause a electric shock or a fire due to over-heating.

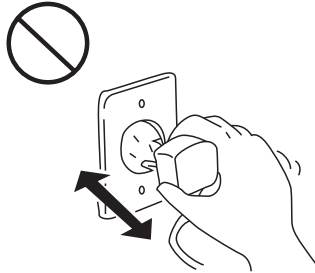

- **Never use damaged electric wires or unspecified electric wires.**
otherwise it may cause a electric shock or a fire.

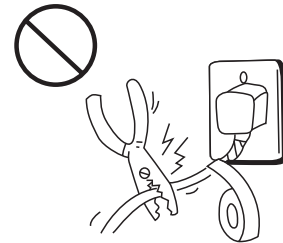

- **Do not use the same socket with other electric appliances or use an extension cord.**
otherwise it may cause a electric shock or a fire due to over-heating.

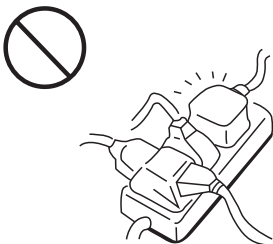

- **Do not operate when the hands are wet.**
due to danger of a electric shock.



- **Do not insert a rod or other objects into the inlet or outlet vents.**
otherwise, it may cause a electric shock or a fire.

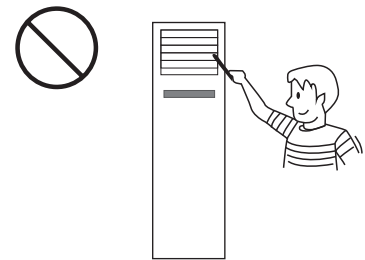

- **Do not expose yourself to a single directional airflow for a long period** to avoid harming to your health.

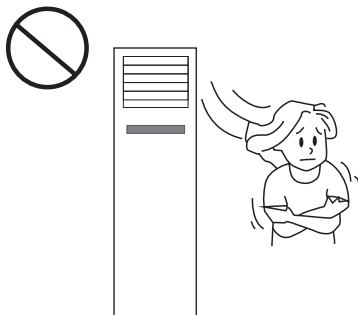

- **In case of abnormal condition (burning smell etc.), pull out the power plug to stop the dehumidifier from running, or disconnect the power supply by means of a electric current protector.**

If the abnormal condition persists, it may cause a electric shock or a fire due to over-heating. Please consult the dealer of service centre as soon as possible to arrange for a repair.

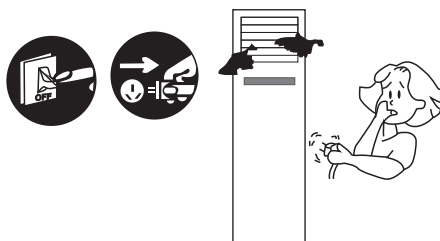

- **Do not attempt to carry out a repair.**
Improper repairs may cause a electric shock or a fire. You should contact the dealer of service centre to arrange for a repair.

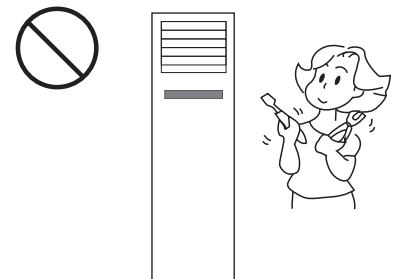

Attention during Usage

- **Do not hold the electric wire to pull out the power plug.**

Pulling of the electric wire may cause over-heating of the electric wire of a fire.



- **If the air-conditioner is not in use for a long time, it is necessary to pull out the power plug.**

Excessive dust on the power plug may also cause over-heating or a fire.

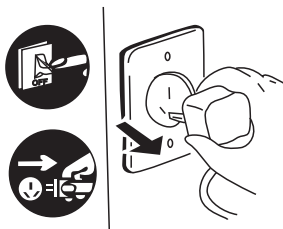

- **Switch off the power supply while cleaning the dehumidifier.**

Please take care not to damage the internal fan which is rotating at a high speed.

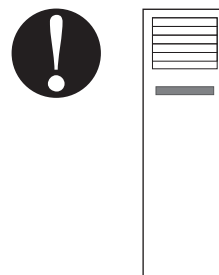

- **Do not use the dehumidifier for other purposes.**

Do not use it for keeping precision instruments, food, plants and artistic items. This may affect the quality of the food.



- **Do not place a heater in front of the dehumidifier.**

If internal combustion of the heater is not complete, it may give out poisonous carbon monoxide.

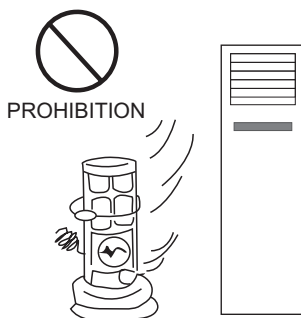

- **Do not pour water onto the dehumidifier for cleaning.**

Due to danger of electric shocks.



Principle of dehumidifier

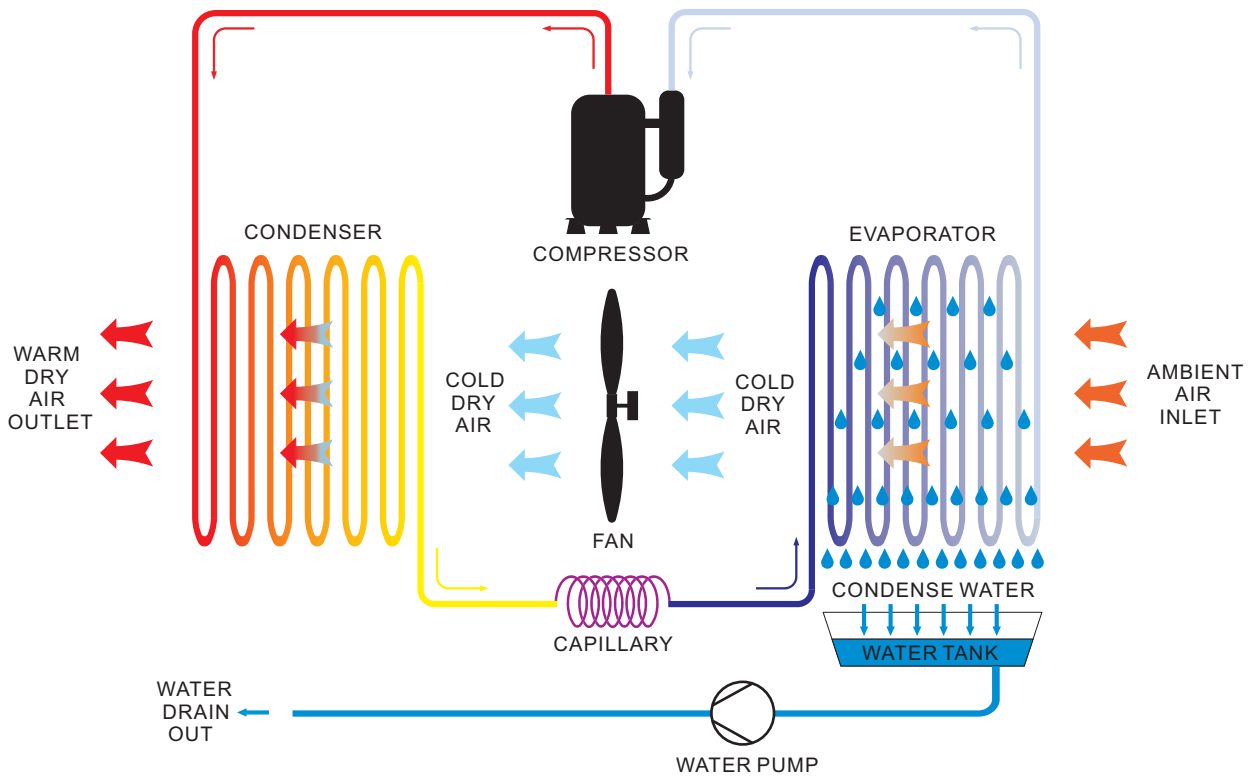

The dehumidifier use the refrigeration circuit to change the damp air warm dry air. When the damp air passes the condenser, the air water will be condensed and the air will become dry.

The Specification Of Dehumidifier (R410a)					
Model	DS-045	DS-060	DS-080	DS-011	DS-014
Capacity (L/hr)	4.5	6	8	11	14
Heating capacity (W)	2400	3200	4200	5700	7400
Power consumption (W)	1200	1700	2200	2800	3400
Air flow (m ³ /hr)	540	720	920	1300	1500
Refrigerant (g)	960	1250	1600	2150	2540
Power supply	230V/50Hz/1Ph	230V/50Hz/1Ph	230V/50Hz/1Ph	400V/50Hz/3Ph	400V/50Hz/3Ph
Current (A)	6.2	7.6	9.8	4	5.2
Aux electric heater (W) (option)	700	700	700	1500	1500
Compressor type	Rotary	Rotary	Rotary	Rotary or Scroll	Scroll
Compressor (brand name)	Daikin or sanyo	Daikin or sanyo	Daikin or sanyo	Daikin or sanyo	Daikin or sanyo
Water pump	Yes	Yes	Yes	Yes	Yes
Applicable area (m ²)	100-150	150-200	200-250	250-300	300-400
Noise (dB (A))	47	48	53	56	60
Drain pipe (mm)	500	500	500	500	500
Packing dimension (mm) (WxHxD)	562x1820x480	562x1820x480	562x1820x480	680x2004x540	680x2004x540
Unit dimension (mm) (WxHxD)	482x1724x400	482x1724x400	482x1724x400	600x1900x460	600x1900x460
Weight (net/gross) (kg)	70/80	78/88	85/95	120/134	135/147
Test condition: Dry ball temperature 30°C. Relative humidity of 80RH%.					

Descriptions of Parts

- ① Air Outlet
- ② Control Panel
- ③ Air filter (inside)
- ④ Air Inlet
- ⑤ Humidity sensor
- ⑥ Indoor temperature sensor
- ⑦ Water drainage system
- ⑧ Four way valve
- ⑨ Compressor

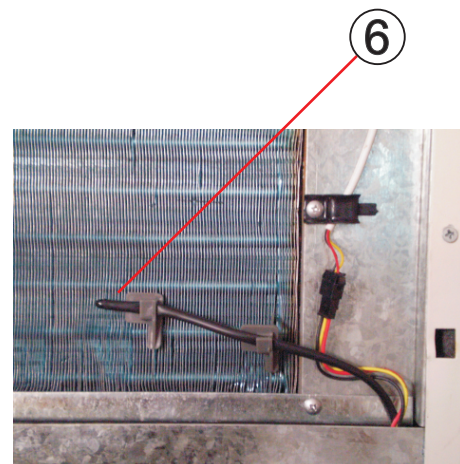
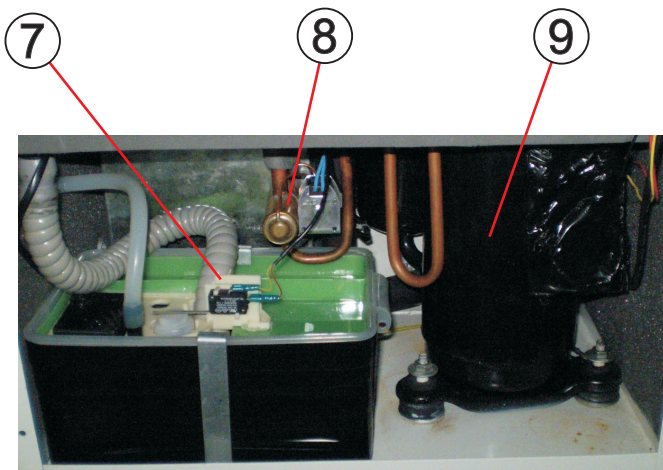
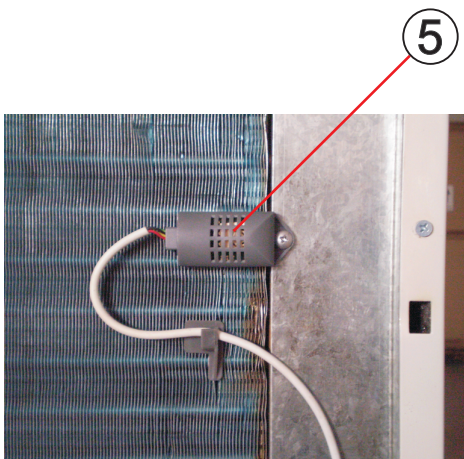
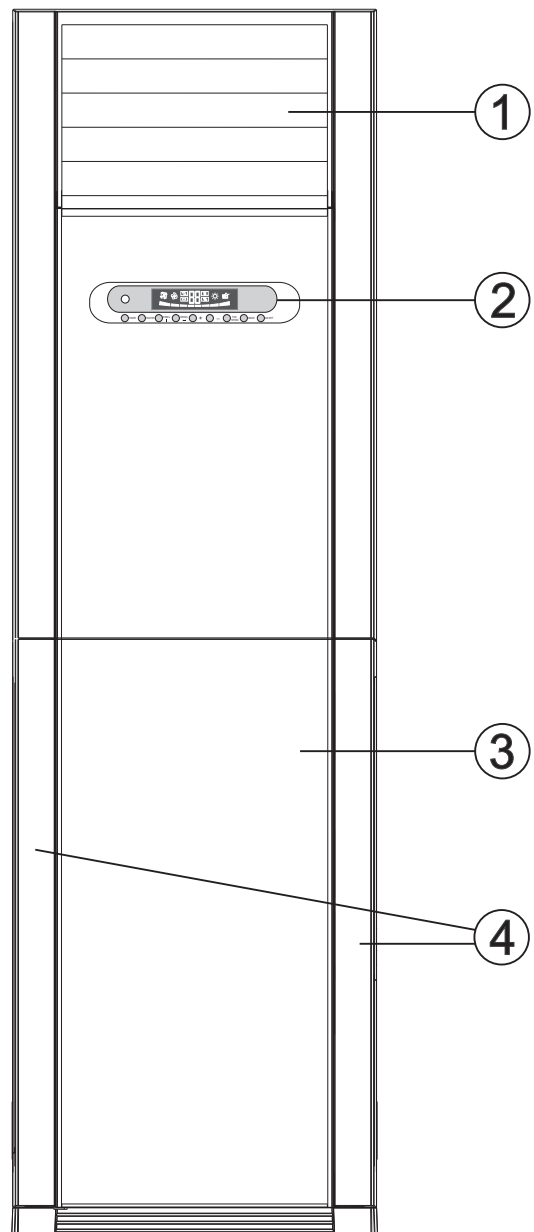

Panel Control

Signal Receiver

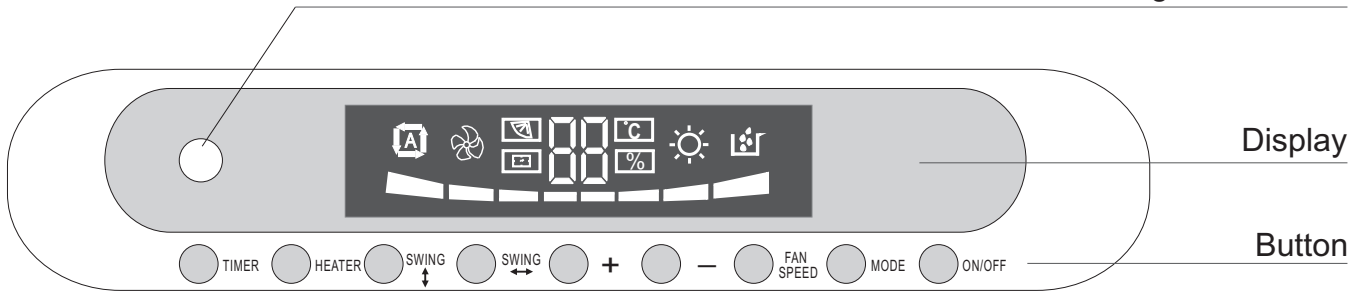

Display

Button

Button

ON / OFF

Press the button to start operation, press the button again to stop operation.

MODE

Mode is selected in a sequence: Automatic ; Dehumidifying ; Fan ; Heating.

FAN SPEED

Select the fan speed. Each time press the button; fan speed is selected in a sequence: LOW , MID , HIGH.

+ / -

One press of the " + " button to raise the temperature by 1 °C; One press of the " - " button to lower the temperature by 1 °C.

SWING ↔

Set the swing or stop of Left-Right Airflow vane.

SWING ↑↓

Set the swing or stop of Up-Down Airflow vane.

HEATER

Press once to switch on assistant heater; Press again to switch off assistant heater.

TIMER

Set the TIMER ON / OFF.

Display

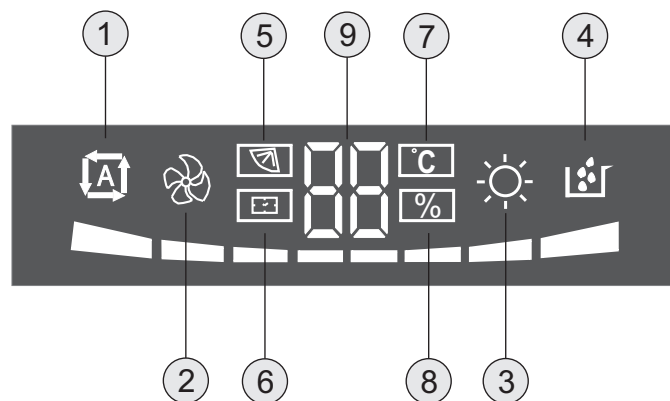

① Auto operation mode

② Fan operation mode

③ Heating operation mode

④ Dehumidifying operation mode

⑤ Swing

⑥ Displays when turns to CLOCK status

⑦ Displays when turns to TEMPERATURE status

⑧ Displays when turns to HUMIDITY status

⑨ CLOCK or TEMPERATURE or HUMIDITY display

Remote Controller

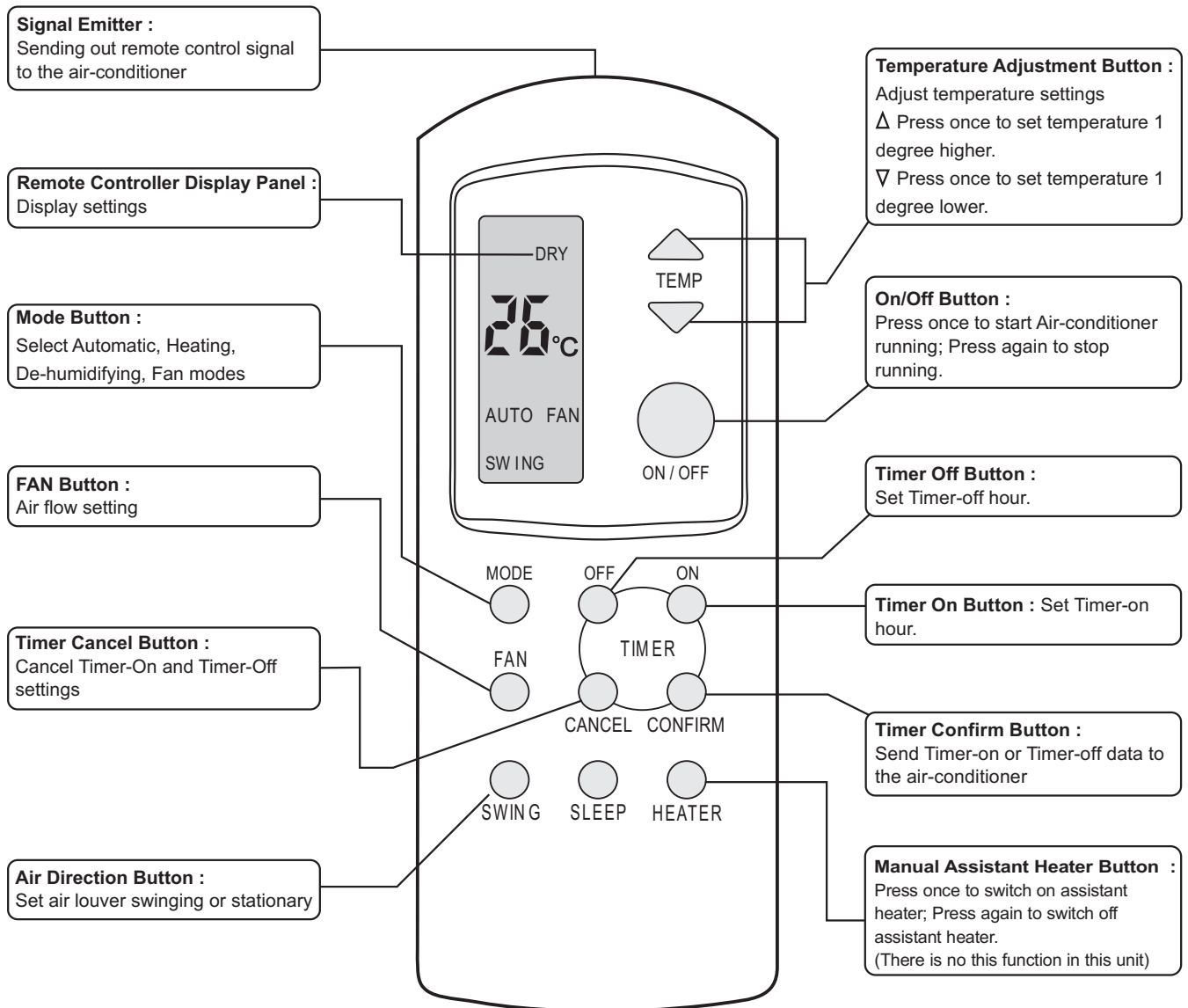

Remote Controller

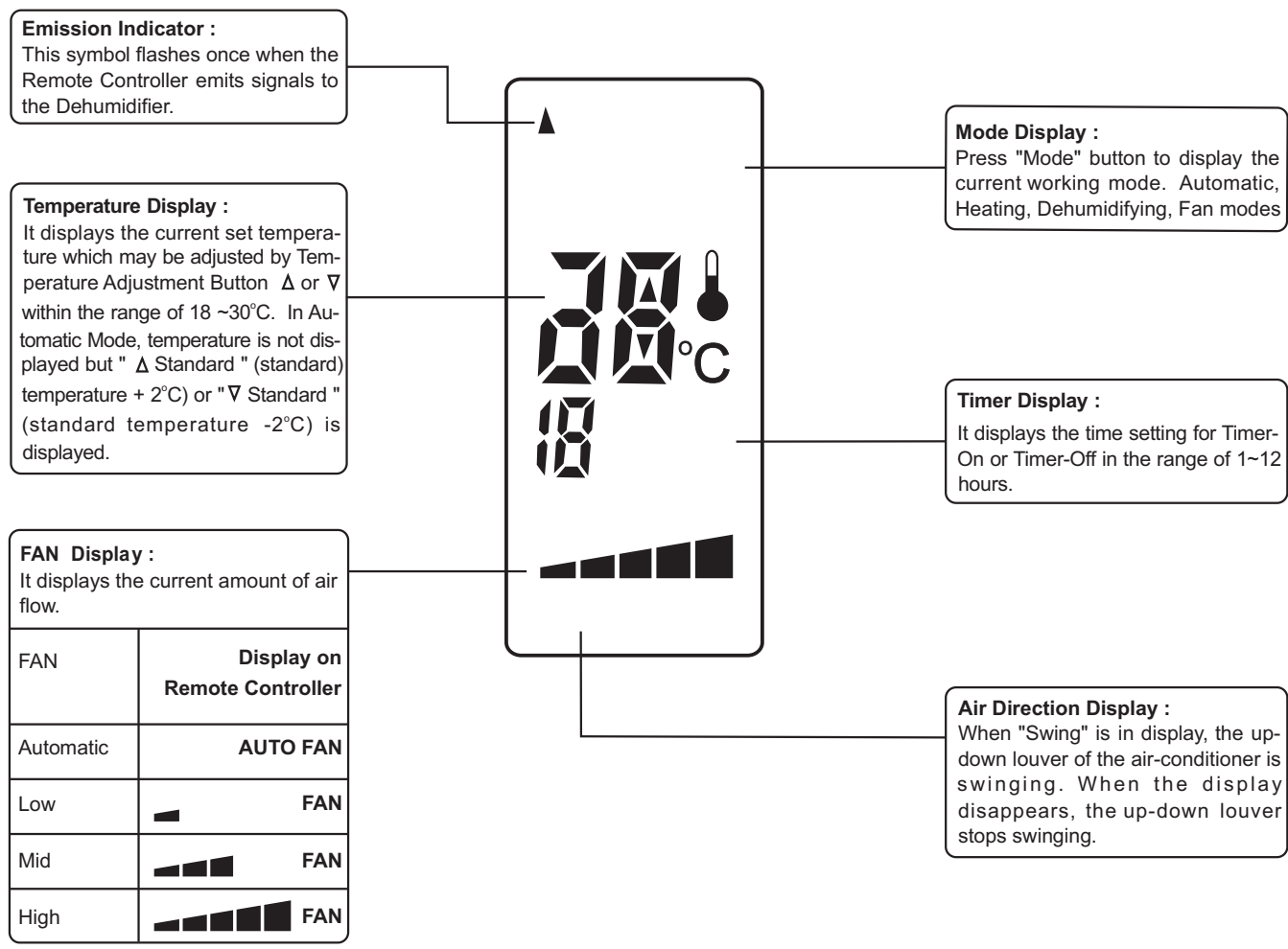

NOTE:

All Displays on the diagram are listed out for demonstration. During operation, only the relevant Display will appear on the Remote Controller.

Operation Guide

Proper settings of Heating, Dehumidifying and Fan modes

Mode Selection (1)

Press "Mode" button to select the required working mode, which is changed in the following sequence when pressed once:

Automatic → Dehumidifying → Fan → Heating

NOTE:

- Heating mode is available only on cooling-heating type air conditioner.
- Automatic operation will be explained in detail on next page.

Air Flow Selection (2)

Press "FAN" button to select the required amount of air flow, which is changed in the following sequence when pressed once :

Automatic → Low → Mid → High

NOTE:

- When Automatic FAN is selected, the air-conditioner will automatically select the suitable amount of air flow according to room temperature.
- When Dehumidifying is selected, the amount of air flow is set by the machine and fan setting is not functional.

Temperature Setting Selection (3)

Press "Temperature Adjustment Button Δ " to set temperature 1 degree higher.

Press "Temperature Adjustment Button ∇ " to set temperature 1 degree lower.

Hold down the Button to increase or decrease the temperature settings progressively.

NOTE:

- Range of adjustable temperature settings : 16°C ~ 31°C.

Starting Operation (4)

Press "On/Off" button, and when the unit receives the signal, it gives out two "beep" tones, the operation light is on and the dehumidifier starts operation.

NOTE:

- If it is desired to run the machine at the same settings for mode, air flow and temperature as the last operation, skip Steps 1~3 and start the machine directly.
If the interval is shorter than 3 minutes from last shut down to the present switch-on, the compressor only re-starts after 3 minutes to protect the system.
After switching on and if the mode is changed, the system may delay for 3 minutes before starting operation.
When heating mode is selected, the internal fan will delay operation for a while when the machine is switched on to prevent cool air circulation at the beginning.
After switching on, air flow amount and temperature may be separately adjusted as desired.

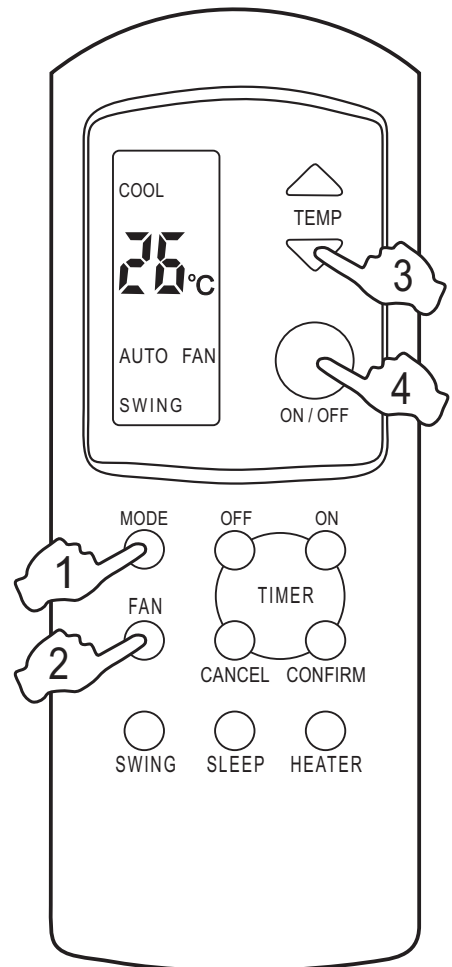

AUTO Operation Mode

Automatic operation Mode

Mode Selection (1)

Press "Mode" button to select Automatic Operation mode.

Fan Selection (2)

Press "FAN" button to select the required amount of air flow, which is changed in the following sequence when pressed once :

Automatic → Low → Mid → High

↑

NOTE:

- When Automatic FAN is selected, the unit will automatically select the suitable amount of air flow according to room temperature.

Starting Operation (3)

Press " On/Off " button, and when the unit receives the signal, it gives out two " beep " tones, the operation light is on and the dehumidifier starts operation is automatic mode.

NOTE:

- In automatic mode, the dehumidifier automatically selects "Dehumidifying" , "Heating" modes depending on room temperature and the humidity, with details as the following table:

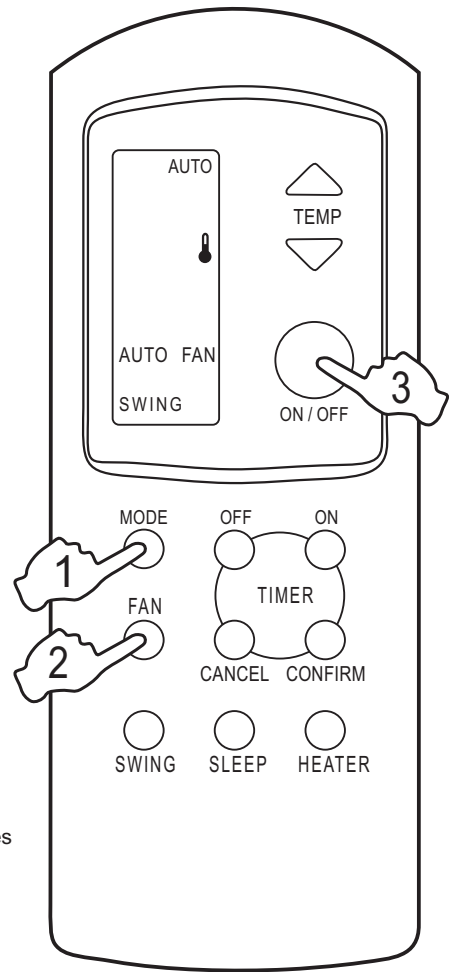

Temperature	< 23°C or > 28°C	23°C ~ 28°C	< 23°C or > 28°C
Model	humidity: > 80%		humidity: < 80%
Dehumidify	Working	Working	Not Working
Heating	Not Working	Not Working	Working

Adjustment in Automatic Mode

Feeling	Button	Operation
Unsuitable fan speed	FAN	Press once to change the air flow progressively until the suitable air flow is selected.

Air Direction Adjustment

Up-Down Air Direction Adjustment

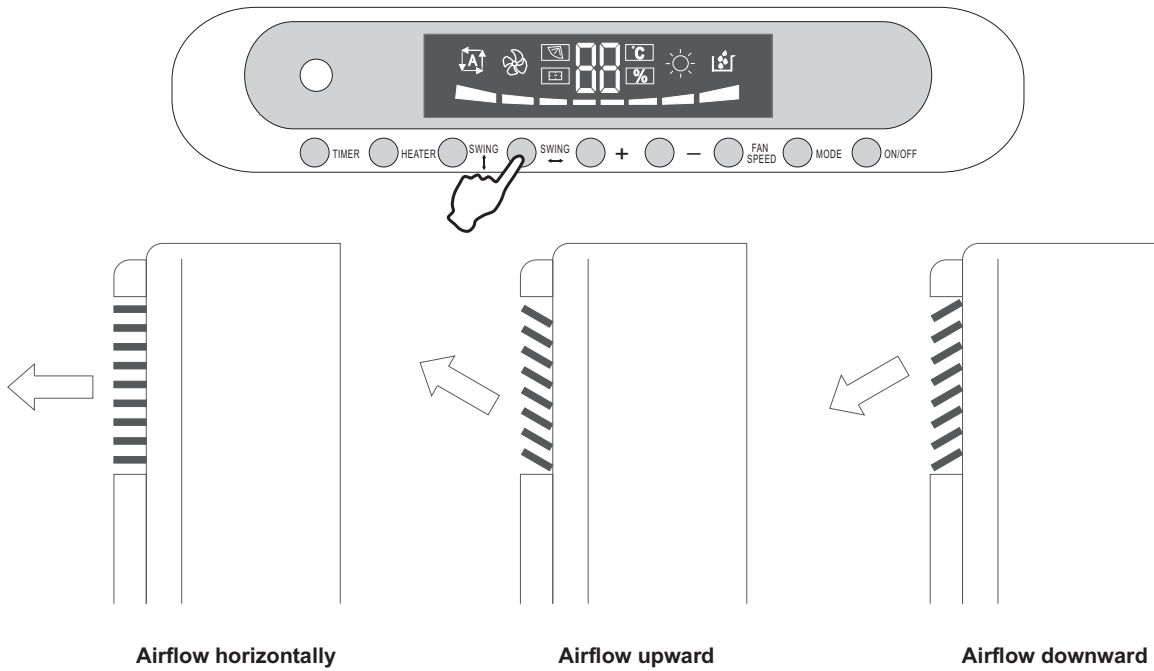

NOTE:

- To stop the up-down air louver in a desired position, set the louver to automatic swinging and when it reaches the desired position, stop the louver from swinging. It is necessary to adjust the louver angle by means of the remote controller, Setting of the louver with the hand may affect its normal operation, in which event, switch off the unit temporarily and re-start operation.
- To get the best effect, the up-down air flow is usually set in the following manner :
Dehumidifying - Horizontal air direction or upward air direction. Heating - Downward air direction.

Changing Left-Right Air Direction

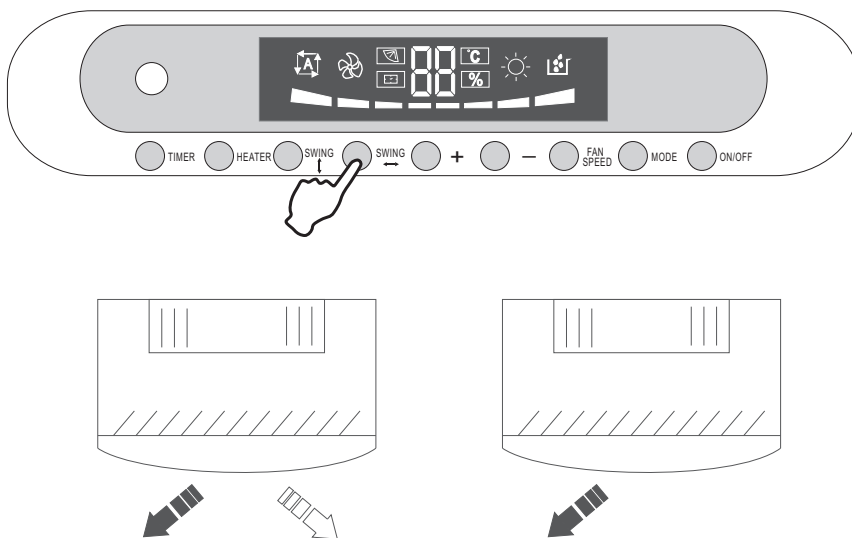

NOTE:

- Don't move the Left-Right vane directly.

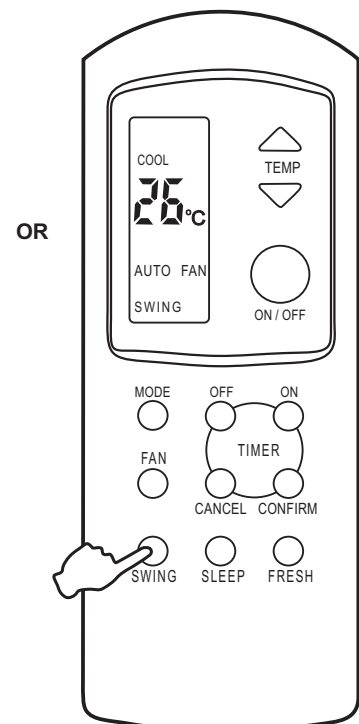

Timer Operations

Timer Switch On

1. Press "Timer On" button to set time for timer-on switching. Press the button once to change the time interval of 1 hour in a cyclic manner of 6, 7, 8 ...12..1, 2..5,6 (The display is showing the previous time as the starting time of the present setting)
If the button is held down, the time interval will increase progressively by 1 hour unit.
2. Point the remote controller towards the receiver on the unit, press "Timer Confirm" button to send the timer setting to the dehumidifier. Then the timer light on the unit lights up, indicating that the unit is in the timer mode. When it reaches the switch-on time, the dehumidifier will operate in the pre-set modes.

NOTE:

- Before timer operation, please set the operation mode, temperature, air flow etc. on the remote controller, With timer being set to switch-on mode. the Dehumidifier will operate according to the last setting.
- Usually, timer-on setting is made while the dehumidifier is not in operation. If timer-on is set while the dehumidifier is running, then the unit will shut down immediately and re-start at the pre-set time.
- If the "On-Off" button is pressed while the unit is under timer-on setting, then the unit will start immediately, the timer setting is cancelled and the timer light will be off.

Timer Switch Off

1. Press "Timer Off" button to set time for timer-off switching. Press the button once to change the time interval of 1 hour in a cyclic manner of 6, 7, 8 ...12..1, 2..5,6 (The display is showing the previous time as the starting time of the present setting)
If the button is held down, the time interval will increase progressively by 1 hour unit.
2. Press "Timer Confirm" button to send the timer setting to the Dehumidifier. Then the timer light on the unit lights up, indicating that the unit is in the timer mode. When it reaches the switch-off time, the air-conditioner will automatically shut down.

NOTE:

- Timer-Off can only be set when the Dehumidifier is running.
- Timer-On and Timer-Off cannot be set at the same time.
- Timer display on the remote controller : While time passes, the display shows the remaining time.
- If the "On-Off" button is pressed while the unit is under timer-off setting, then the unit will shut down immediately, the timer setting is cancelled and the timer light will be off.

Timer Cancellation

Press "Timer-Cancel" button to cancel the timer-on or timer-off settings.

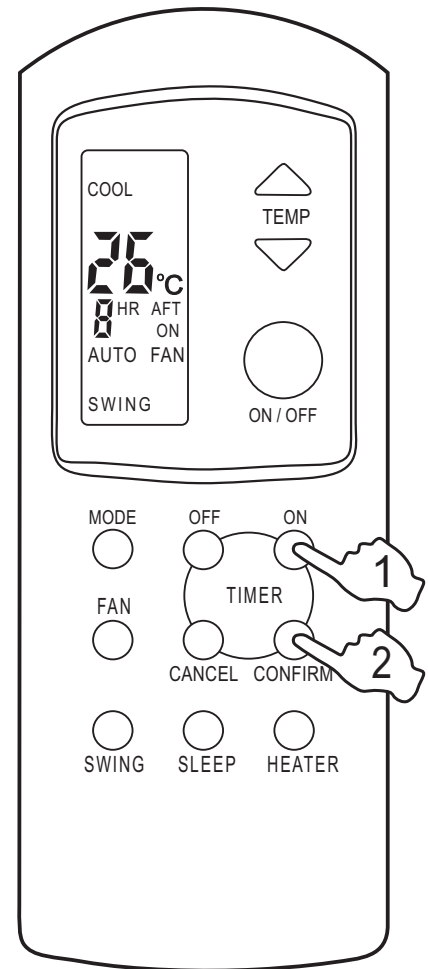

Defrost system

Sequences of the defrosting:

1- Start

The defrosting is engaged if the following conditions are at the same time fulfilled:

- the compressor and the fan motor run without stopping;
- the defrosting sensor temperature lower than 3°C, and the duration of time more than 45 minutes;
- the defrosting sensor temperature goes down to -7°C.

2- After 15 seconds, the 4 way valve shifts.

3- Five seconds after its stop, the compressor starts alone ; And the accumulated freeze on the gills becomes melting, what is generally with a steam cloud .

4- Stop:

The defrosting stops if one of the following conditions is fulfilled:

- the defrosting operates 20 seconds and the detected temperature by the defrost sensor goes up to 12°C;
- the compressor had run totally 8 minutes.

5- The compressor runs.

6- After 15 seconds the 4 way valve shifts

7- Five seconds after its stop the compressor and the fan start for restarting in heating mode.

8- The running light is blinking during defrosting.

Water drainage system

During the dehumidify mode, the condenser water will be drained into the internal water tank .When the water reaches the certain level, the water drain pump will work. If the water can be drained out in 8 mins, the dehumidifier will keep working. If not, the compressor and the motor will stop working. Mean while an error message “ E4 “ will appear in the control panel to inform you to empty the water.

In this instance, you should cut the power off, and then restart the dehumidifier ,and the operation will continue .

Error Codes

- E1 : Room temperature sensor error;
- E2 : Defrost temperature sensor error;
- E3 : Humidity sensor error;
- E4 : Drain error;

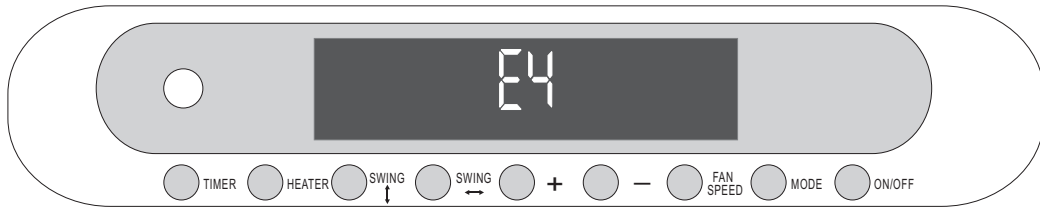

Wiring diagram

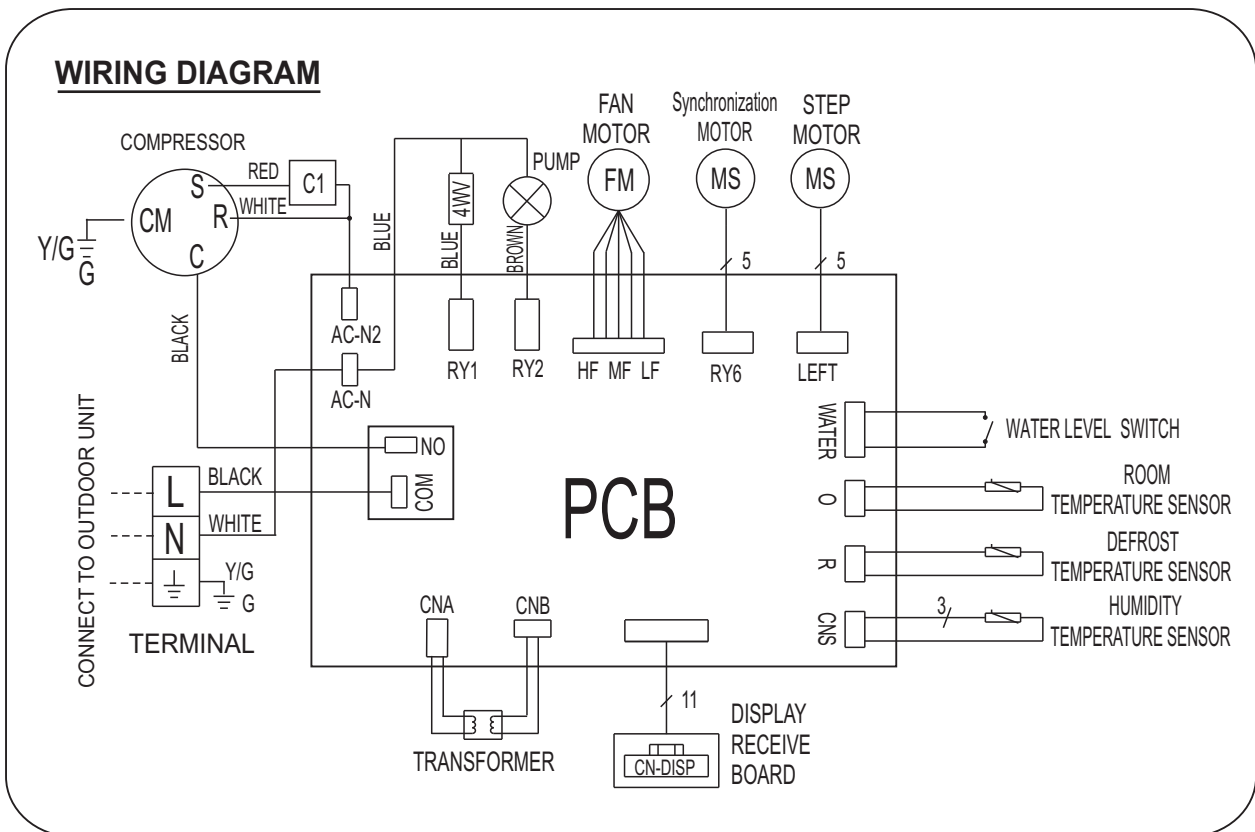

Maintenance

For smart use of the Dehumidifier:

Setting of proper room temperature

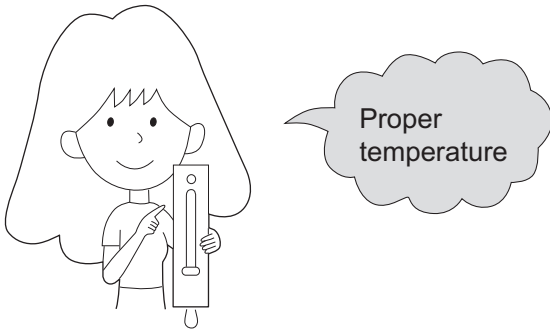

Do not block the air inlet or outlet

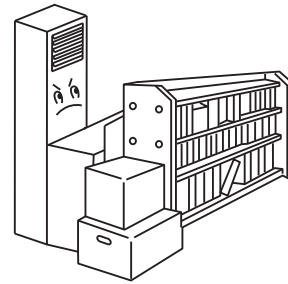

Close doors and windows during operation

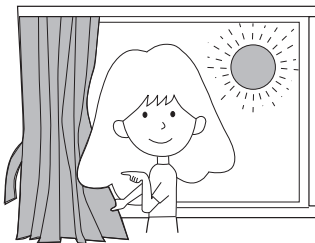

Use the timer effectively

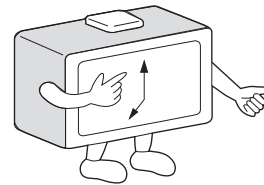

If the unit is not to be used for a long time, turn off the power supply main switch.

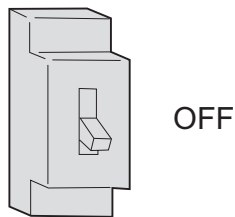

Use the louvers effectively



Maintenance

For smart use of the Dehumidifier:

⚠ WARNING

Before maintenance, be sure to turn off the system and the circuit breaker.

Remote Controller



Do not use water, wipe the controller with a dry cloth. Do not use glass cleaner or chemical cloth.

Body

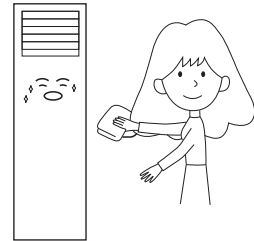

Wipe the air conditioner by using a soft and dry cloth. For serious stains, use a neutral detergent diluted with water. Wring the water out of the cloth before wiping. then wipe off the detergent completely.

Do not use the following for cleaning



Gasoline, benzine, thinner or cleanser may damage the coating of the unit.



Hot water over 40 °C (104 °C) may cause discoloring or deformation.

Air Filter cleaning

Press the clasp on the top of the grill and pull the grill out, and then the filter will be taken out along a gradient way.

➤ Clean the filter.

Use a vacuum cleaner to remove dust, or wash the filter with water. After washing, dry the filter completely in the shade. Then, reinstall it onto the unit.

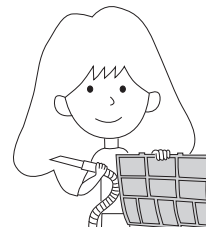

Once every two weeks

Maintenance

To keep your Dehumidifier in good condition after season:

1. Operate in FAN mode for about half a day.

On a fine day, unit shall be started and operate in FAN mode for about half a day until the inside of the unit becomes thoroughly dry.

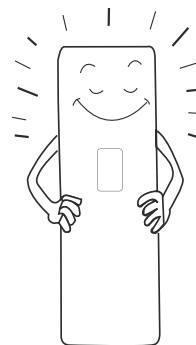

2. Turn off the power supply main switch.

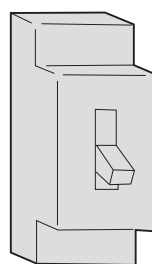

OFF

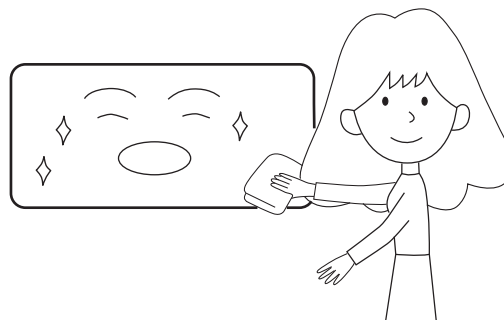

3. Cleaning the body.

4. Take out the batteries from the wireless remote controller.



Trouble shooting

Before asking for service, check the following first.

	Phenomenon	Cause or check points
Normal Performance inspection	<p>The system does not restart immediately.</p> 	<ul style="list-style-type: none"> • When unit is stopped, it won't restart immediately until 3 minutes have elapsed to protect the system. • When the electric plug is pulled out and reinserted, the protection circuit will work for 3 minutes to protect the dehumidifier.
	<p>Noise is heard:</p> 	<ul style="list-style-type: none"> • During unit operation or at stop, a swishing or gurgling noise may be heard. At first 2-3 minutes after unit start, this noise is more noticeable. (This noise is generated by refrigerant flowing in the system.) • During unit operation, a cracking noise may be heard. This noise is generated by the casing expanding or shrinking because of temperature changes. • Should there be a big noise from air flow in unit operation, air filter may be too dirty.
	<p>Smells are generated.</p>	<ul style="list-style-type: none"> • This is because the system circulates smells from the interior air such as the smell of furniture, cigarettes.
Multiple check	Does not work at all.	<ul style="list-style-type: none"> • Is power plug inserted? • Is there a power failure? • Is fuse blown out?
	Inefficient	<ul style="list-style-type: none"> • Is the air filter dirty? Normally it should be cleaned every 15 days. • Are there any obstacles before inlet and outlet? Is temperature set correctly? • Are there some doors or windows left open?